

SCALE 1/2

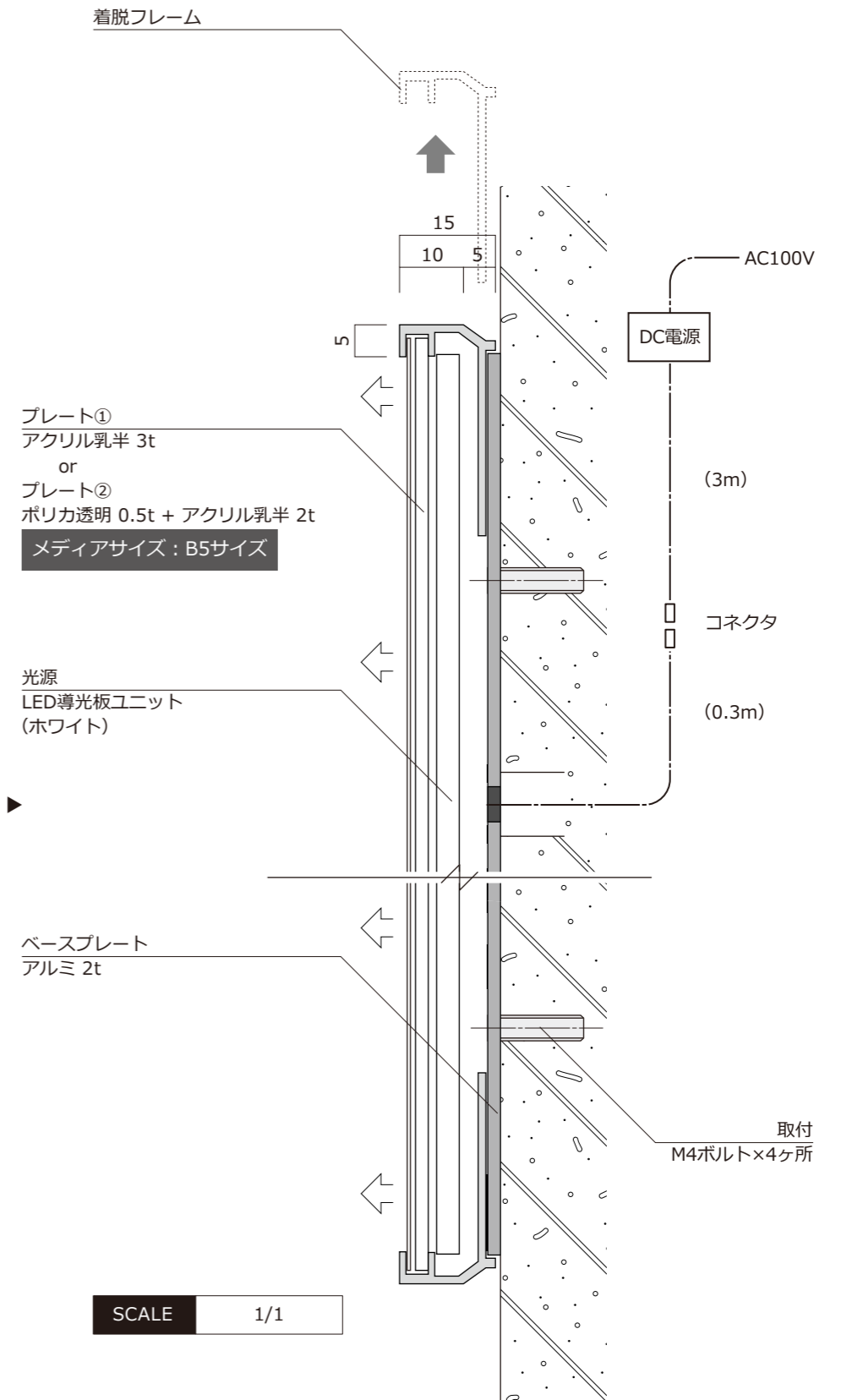
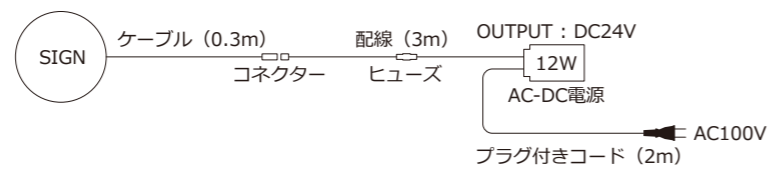

SCALE 1/1

※当社製品の寸法公差は±0.5mmとします。